



Visualisation; Diagnostics

Easy to Configure

Programming IEC 61131-3

Rapid Installation

**PSEN ma1.4a-50**

**PILZ**

THE SPIRIT OF SAFETY

► PSEN sensor technology

This document is a translation of the original document.

All rights to this documentation are reserved by Pilz GmbH & Co. KG. Copies may be made for internal purposes. Suggestions and comments for improving this documentation will be gratefully received.

Source code from third-party manufacturers or open source software has been used for some components. The relevant licence information is available on the Internet on the Pilz homepage.

Pilz®, PIT®, PMI®, PNOZ®, Primo®, PSEN®, PSS®, PVIS®, SafetyBUS p®, SafetyEYE®, SafetyNET p®, the spirit of safety® are registered and protected trademarks of Pilz GmbH & Co. KG in some countries.



SD means Secure Digital

<b>Introduction</b>	<b>4</b>
Validity of documentation	4
Using the documentation	4
Definition of symbols	4
<b>Safety</b>	<b>5</b>
Intended use	5
Safety regulations	5
Safety assessment	5
Use of qualified personnel	6
Warranty and liability	6
Disposal	6
For your safety	6
<b>Unit features</b>	<b>7</b>
<b>Function description</b>	<b>7</b>
Block diagram	7
Operating distances	8
Lateral and vertical offset	8
<b>Wiring</b>	<b>9</b>
Pin assignment	9
<b>Requirements and connection to evaluation devices</b>	<b>10</b>
<b>Installation</b>	<b>12</b>
Installation type 1	13
Installation type 2	14
<b>Adjustment</b>	<b>15</b>
<b>Periodic test</b>	<b>16</b>
<b>Dimensions in mm</b>	<b>16</b>
<b>Technical details</b>	<b>16</b>
Safety characteristic data	18
<b>Order reference</b>	<b>19</b>
System	19
Accessories	19
<b>EC declaration of conformity</b>	<b>19</b>

## Introduction

### Validity of documentation

This documentation is valid for the product PSEN ma1.4a-50. It is valid until new documentation is published.

This operating manual explains the function and operation, describes the installation and provides guidelines on how to connect the product.

### Using the documentation

This document is intended for instruction. Only install and commission the product if you have read and understood this document. The document should be retained for future reference.

### Definition of symbols

Information that is particularly important is identified as follows:



#### **DANGER!**

This warning must be heeded! It warns of a hazardous situation that poses an immediate threat of serious injury and death and indicates preventive measures that can be taken.



#### **WARNING!**

This warning must be heeded! It warns of a hazardous situation that could lead to serious injury and death and indicates preventive measures that can be taken.



#### **CAUTION!**

This refers to a hazard that can lead to a less serious or minor injury plus material damage, and also provides information on preventive measures that can be taken.



#### **NOTICE**

This describes a situation in which the product or devices could be damaged and also provides information on preventive measures that can be taken. It also highlights areas within the text that are of particular importance.

**INFORMATION**

This gives advice on applications and provides information on special features.

**Safety****Intended use**

The safety function of the safety switch is:

- ▶ Safe detection of the magnetic actuator within the response range

The safety switch meets the requirements in accordance with:

- ▶ EN 60947-5-3: PDDB only in connection
  - with the operator PSEN ma1.4-03 or operator PSEN ma1.4-10 and
  - the suitable evaluation devices (see [Requirements and connection to evaluation devices](#) [ 10]).

The following is deemed improper use in particular:

- ▶ Any component, technical or electrical modification to the product
- ▶ Use of the product outside the areas described in this manual
- ▶ Use of the product outside the technical details (see [Technical details](#) [ 16]).

**NOTICE****EMC-compliant electrical installation**

The product is designed for use in an industrial environment. The product may cause interference if installed in other environments. If installed in other environments, measures should be taken to comply with the applicable standards and directives for the respective installation site with regard to interference.

**Safety regulations****Safety assessment**

Before using a unit it is necessary to perform a safety assessment in accordance with the Machinery Directive.

Functional safety is guaranteed for the product as a single component. However, this does not guarantee the functional safety of the overall plant/machine. In order to achieve the required safety level for the overall plant/machine, define the safety requirements for the plant/machine and then define how these must be implemented from a technical and organisational standpoint.

### Use of qualified personnel

The products may only be assembled, installed, programmed, commissioned, operated, maintained and decommissioned by competent persons.

A competent person is a qualified and knowledgeable person who, because of their training, experience and current professional activity, has the specialist knowledge required. To be able to inspect, assess and operate devices, systems and machines, the person has to be informed of the state of the art and the applicable national, European and international laws, directives and standards.

It is the company's responsibility only to employ personnel who

- ▶ Are familiar with the basic regulations concerning health and safety / accident prevention,
- ▶ Have read and understood the information provided in this description under "Safety"
- ▶ Have a good knowledge of the generic and specialist standards applicable to the specific application.

### Warranty and liability

All claims to warranty and liability will be rendered invalid if

- ▶ The product was used contrary to the purpose for which it is intended
- ▶ Damage can be attributed to not having followed the guidelines in the manual
- ▶ Operating personnel are not suitably qualified
- ▶ Any type of modification has been made (e.g. exchanging components on the PCB boards, soldering work etc.).

### Disposal

- ▶ In safety-related applications, please comply with the mission time  $T_M$  in the safety-related characteristic data.
- ▶ When decommissioning, please comply with local regulations regarding the disposal of electronic devices (e.g. Electrical and Electronic Equipment Act).

### For your safety



#### WARNING!

Loss of safety function due to manipulation of the interlocking device

Manipulation of the interlocking device may lead to serious injury and death.

- You should prevent any possibility of the interlocking device being manipulated through the use of a spare actuator.
- Keep the substitute actuator in a safe place and protect it from unauthorised access.
- If spare actuators are used, these must be installed as described in [Installation](#) [ 12].
- If the original actuators are replaced with substitute actuators, the original actuators must be destroyed before disposal.



## Unit features

- ▶ The actuator PSEN ma1.4-03 or PSEN ma1.4-10 belongs to the safety switch.
- ▶ Coded actuator
- ▶ Safety switch with cable (5 m)
- ▶ 2 safety contacts (reed contacts - N/O)
- ▶ Different operating distances depending on the actuator see [Technical details](#) [ 16]
- ▶ Design:
  - Safety switch with square design
  - Actuator with square design: PSEN ma1.4-03
  - Actuator with square design: PSEN ma1.4-10
- ▶ Operation Magnetic
- ▶ Switching voltage 24 VDC

## Function description

If the actuator is within the response range (safety gate closed), the safety contacts of the safety switch are closed.

Operate the PSEN ma1.4a-50 in conjunction with the following components:

- ▶ Actuator PSEN ma1.4-03 or actuator PSEN ma1.4-10 (see [Order reference](#) [ 19]) and
- ▶ a connected evaluation device (see [Requirements and connection to evaluation devices](#) [ 10]).

## Block diagram

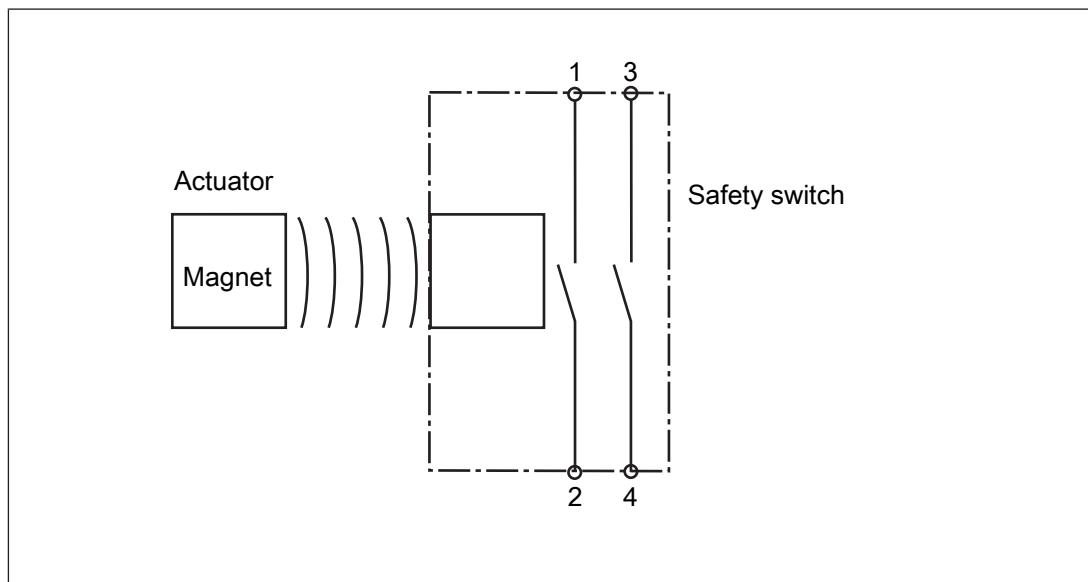

**Operating distances**

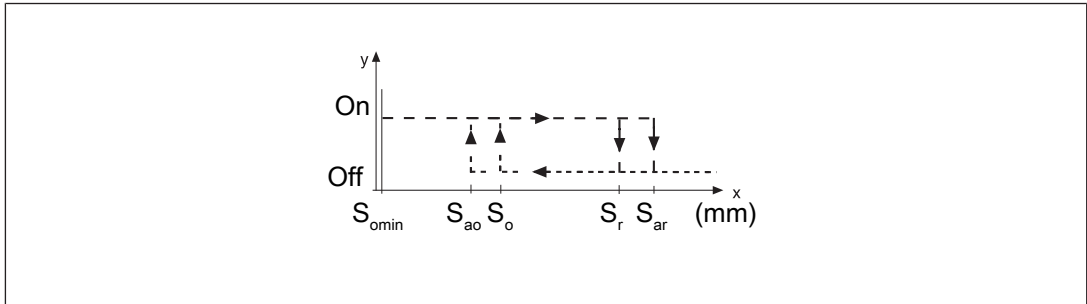

**Legend**

- $S_{ao}$  Assured operating distance
- $S_{omin}$  Min. operating distance
- $S_{ar}$  Assured release distance

The offset-independent values for the switching distances are included in the [Technical details](#) [16].

**Lateral and vertical offset**

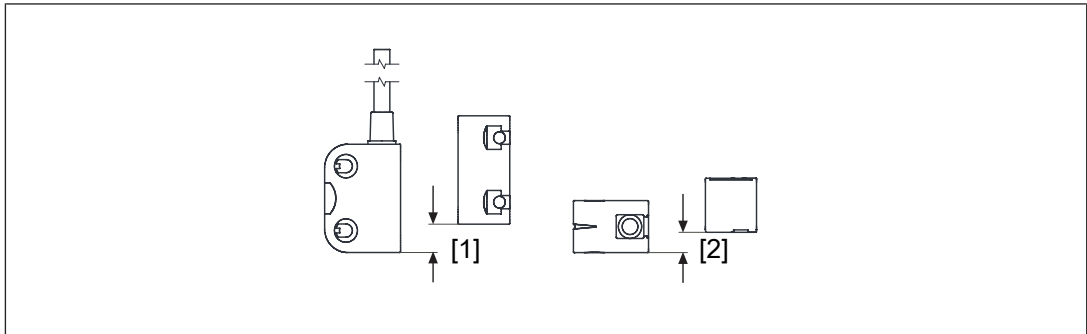

**Legend**

- [1] Lateral offset
- [2] Vertical offset

**Actuator PSEN ma1.4-03**

Assured operating distance $S_{ao}$ in mm						
Vertical offset	Lateral offset					
	0	1	2	3	4	
0	3.0	3.0	2.5	1.5	1.0	
1	3.0	2.5	2.0	0.5	-	
2	2.5	1.5	1.0	-	-	
3	1.5	0.5	-	-	-	
4	0.5	-	-	-	-	

The stated values are valid at a temperature of 20 °C.



**Actuator PSEN ma1.4-10**

Assured operating distance $S_{ao}$ in mm						
Vertical offset	Lateral offset					
		0 mm	2 mm	4 mm	6 mm	8 mm
	0 mm	10.0	10.0	9.0	7.0	5.0
	2 mm	10.0	10.0	8.0	6.0	3.0
	4 mm	9.0	8.0	7.0	5.0	-
6 mm	7.0	6.0	5.0	-	-	

The stated values are valid at a temperature of 20 °C.

**Wiring**

- ▶ Information given in the [Technical details \[16\]](#) must be followed.
- ▶ Calculation of the max. cable length  $l_{max}$ :

$$l_{max} = \frac{R_{lmax} - R_i}{R_l / km}$$

$R_{lmax}$  = Max. overall cable resistance (see evaluation device's technical details)

$R_i$  = Internal resistance sensor (see [Technical details \[16\]](#))

$R_l / km$  = Cable resistance/km of the cable (see technical details cable)

- ▶ Ensure the wiring and EMC requirements of EN 60204-1 are met.
- ▶ In the following cases, check the function that detects shorts across contacts prior to commissioning:
  - On evaluation devices with DC supply voltage: Overall cable resistance  $\geq$  15 Ohms per channel
  - On evaluation devices with AC supply voltage: Overall cable resistance  $\geq$  25 Ohms per channel
  - For details of how to perform the test for shorts across the contacts, please refer to the operating manual for the relevant evaluation device.

**Pin assignment**

**NOTICE**

The colour marking for the connection lead only applies for the cable that Pilz supplies as an accessory

The safety switch is shown in an unoperated condition.

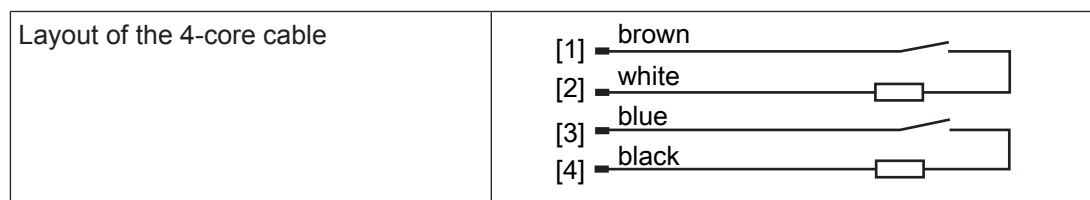

## Requirements and connection to evaluation devices

For use of PSEN ma1.4a-50 in accordance with DIN EN 60947-5-3 an evaluation device must be connected.

Connect the PSEN ma1.4a-50

- ▶ **either** with a certified Pilz evaluation device
- ▶ **or** with an evaluation device with defined properties

**Certified Pilz evaluation devices are, for example:**

- ▶ PNOZelog for safety gate monitoring
  - PNOZ e1p, PNOZ e1.1p, PNOZ e1vp
  - PNOZ e5.11p
  - PNOZ e6vp, PNOZ e6.1p
- ▶ PNOZpower for safety gate monitoring
  - PNOZ p1p, PNOZ p1vp
- ▶ PNOZsigma for safety gate monitoring:
  - PNOZ s3
  - PNOZ s4
  - PNOZ s5
- ▶ PNOZ X for safety gate monitoring
  - PNOZ X2, PNOZ X2.5P, PNOZ X2.7P, PNOZ X2.8P, PNOZ X2.9P, PNOZ X2C,
  - PNOZ X3, PNOZ X3.1, PNOZ X3P, PNOZ X3.10P
  - PNOZ X4
  - PNOZ X5, PNOZ X5J
  - PNOZ Ex
- ▶ PNOZmulti for safety gate monitoring
 

Configure the switch in the PNOZmulti Configurator with switch type 3.
- ▶ PSS for safety gate monitoring with standard function block SB064, SB066 or FS\_Safety Gate
- ▶ PSSuniversal PLC for safety gate monitoring with function block FS\_SafetyGate

The correct connection to the respective evaluation device is described in the operating manual for the evaluation device. Make sure that the connection is made in accordance with the specifications in the operating manual for the selected evaluation device.

**Defined properties of evaluation devices:**

- ▶ 2-channel with feasibility monitoring
- ▶ Open circuit monitoring of the safety switch is performed
- ▶ The inputs and outputs of the evaluation device must fulfil the requirements of IEC 61131
- ▶ Technical data of the evaluation device must fulfil the requirements in the [Technical details \[16\]](#) of PSEN ma1.4a-50
  - Always comply with the max. switching current safety contacts of PSEN ma1.4a-50.

- ▶ Outputs at the evaluation device must only be switched on again when both reed contacts at the safety switch have been opened and closed (partial operation lock)



**INFORMATION**

Risk time in accordance with DIN EN 60947-5-3

The risk time is made up of the reaction time of the sensor (see [Technical details \[16\]](#)) and the processing and delay times of the evaluation device (s. operating manual for the relevant evaluation device).

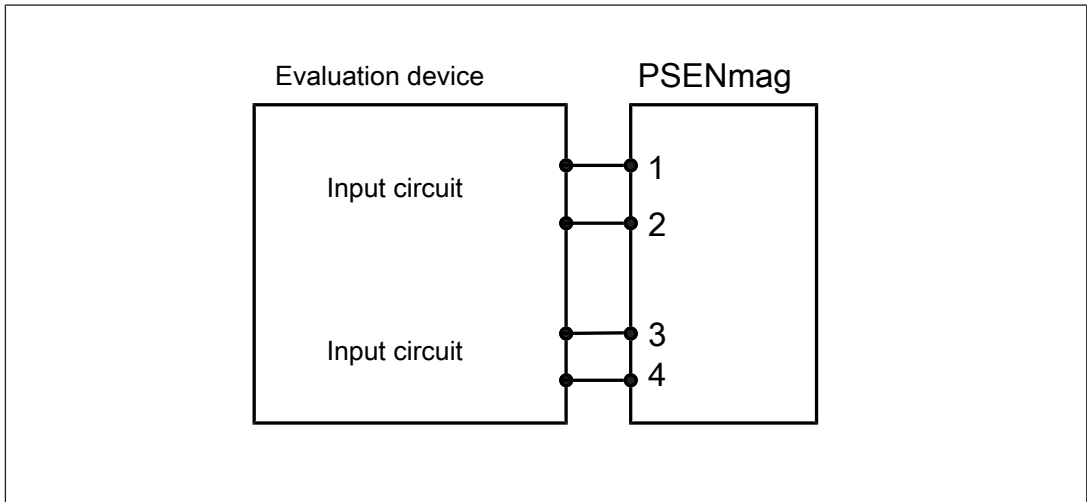
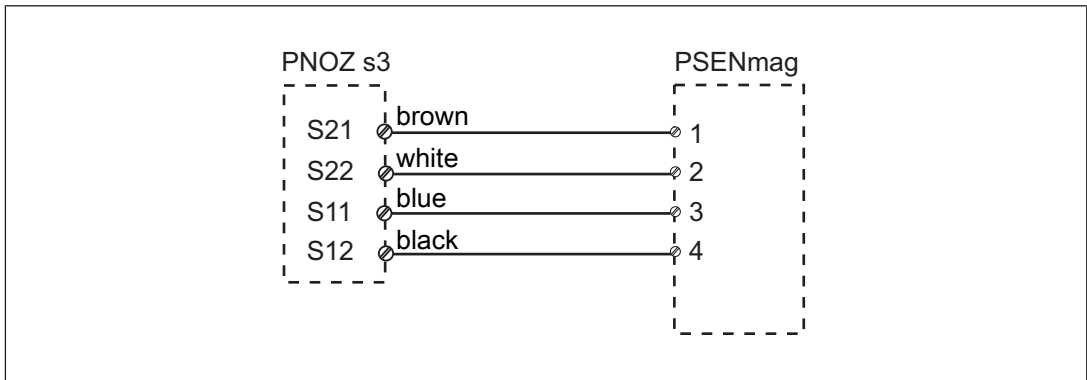
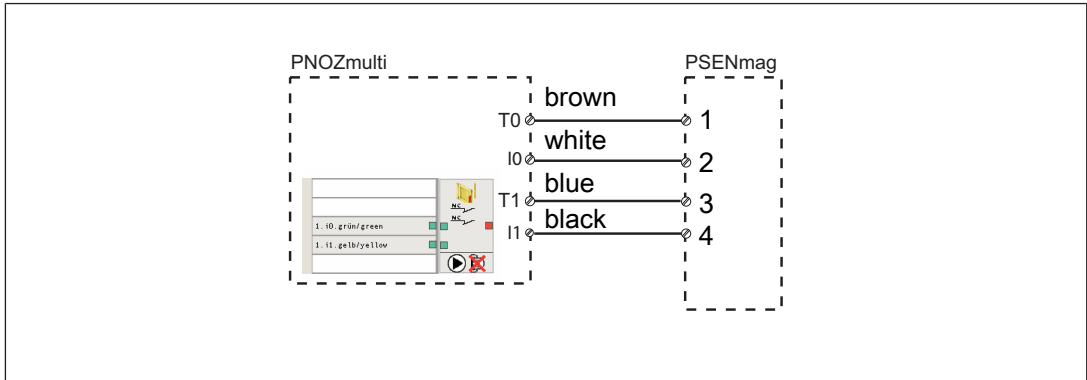

Fig.: Dual-channel connection PSEN ma1.4a-50 to the input circuits of an evaluation device

**Examples for connection to Pilz evaluation devices:**





**Legend**

- I0            Input OSSD
- I1            Input OSSD
- T1, T2       Test pulse outputs

**Installation**

- ▶ The unit can be installed in any position. However, safety switches and actuators must be positioned opposite each other in parallel.
- ▶ If possible, do not install the safety switch and actuator on to ferromagnetic material. Changes to the operating distances are to be expected.
- ▶ Safety switches and actuators should only be secured using M4 screws with a flat head (e.g. M4 cheese-head or pan head screws). Use screws made of non-magnetic material (e.g. brass).



**CAUTION!**

Potential loss of safety function due to changed device properties

The unit's properties may be affected if installed in an environment containing electrically or magnetically conductive material.

- Please check the operating distances and the assured release distance.



**CAUTION!**

Possible loss of the safety function by changing the release distance  $S_{ar}$  with non-flush installation

Installing the safety switch non-flush within electrically or magnetically conductive material, the value for the assured release distance  $S_{ar}$  can change.

- Check the assured release distance  $S_{ar}$ .

- ▶ Safety switches and actuators must be positioned so that they are secured against a change of position.

- ▶ The safety switch and actuator should only be secured using screws and nuts made of non-magnetic material (e.g. brass or stainless steel).
- ▶ Avoid the risk of damages from foreseeable external influences by attaching the safety switch and actuator. If necessary, safety switch and actuator have to be protected.



#### INFORMATION

The actuator should be protected from unauthorised removal and from contamination.

- ▶ Prevent self-loosening of the fastening elements of safety switch and actuator.
- ▶ The fastening of safety switch and actuator has to be sufficiently stable to ensure the proper operation of the safety switch and the actuator.
- ▶ The distance between two safety switches must be maintained (see [Technical details \[16\]](#)).
- ▶ Safety switches and actuators
  - Should be kept away from iron swarf
  - Should not be exposed to strong magnetic fields
  - Should be used for fixed wiring only
- ▶ Prevent the safety switch and actuator being exposed to heavy shock or vibration
- ▶ Make sure that the safety switch and actuator cannot be used as an end stop.
- ▶ Circumvention of the safety switch in a reasonably foreseeable manner must be prevented.
- ▶ Please note the installation measures in accordance with EN ISO 14119 for a proximity switch design 4 and with level of coding Low
- ▶ Alignment errors of the guard must not adversely affect the safety function of the guard.
- ▶ The assured operating distance  $S_{ao}$  and the assured release distance  $S_{ar}$  must be tested under real conditions.

#### Installation type 1

- ▶ 1. Cut the thread (M4) in the required position.
- ▶ 2. Use a screw to fix the sensor.
- ▶ 3. Attach the second screw to the sensor. (Important: do not tighten the screws). Attach the screws for the actuator, maintaining the distance between the screw head and the plate: ca. 3 ... 6 mm.
- ▶ 4. Align actuator to sensor.



#### INFORMATION

The inscribed area on the actuator (sensing face) should face the sensor.

- ▶ 5. Slide the actuator on to the screws.
- ▶ 6. Align sensor and tighten screws with max. 0,8 Nm.

- ▶ 7. Align actuator and tighten screws with max. 0,8 Nm.
- ▶ 8. Close used mounting holes using seal (1) or (4) (see Diagram [14]).
- ▶ 9. Close unused mounting holes using seal (2) (see Diagram [14]).
- ▶ 10. Close mounting holes on the sensing face using seal (3) (see Diagram [14]).
- ▶ 11. Installation of sensor and actuator is now complete.

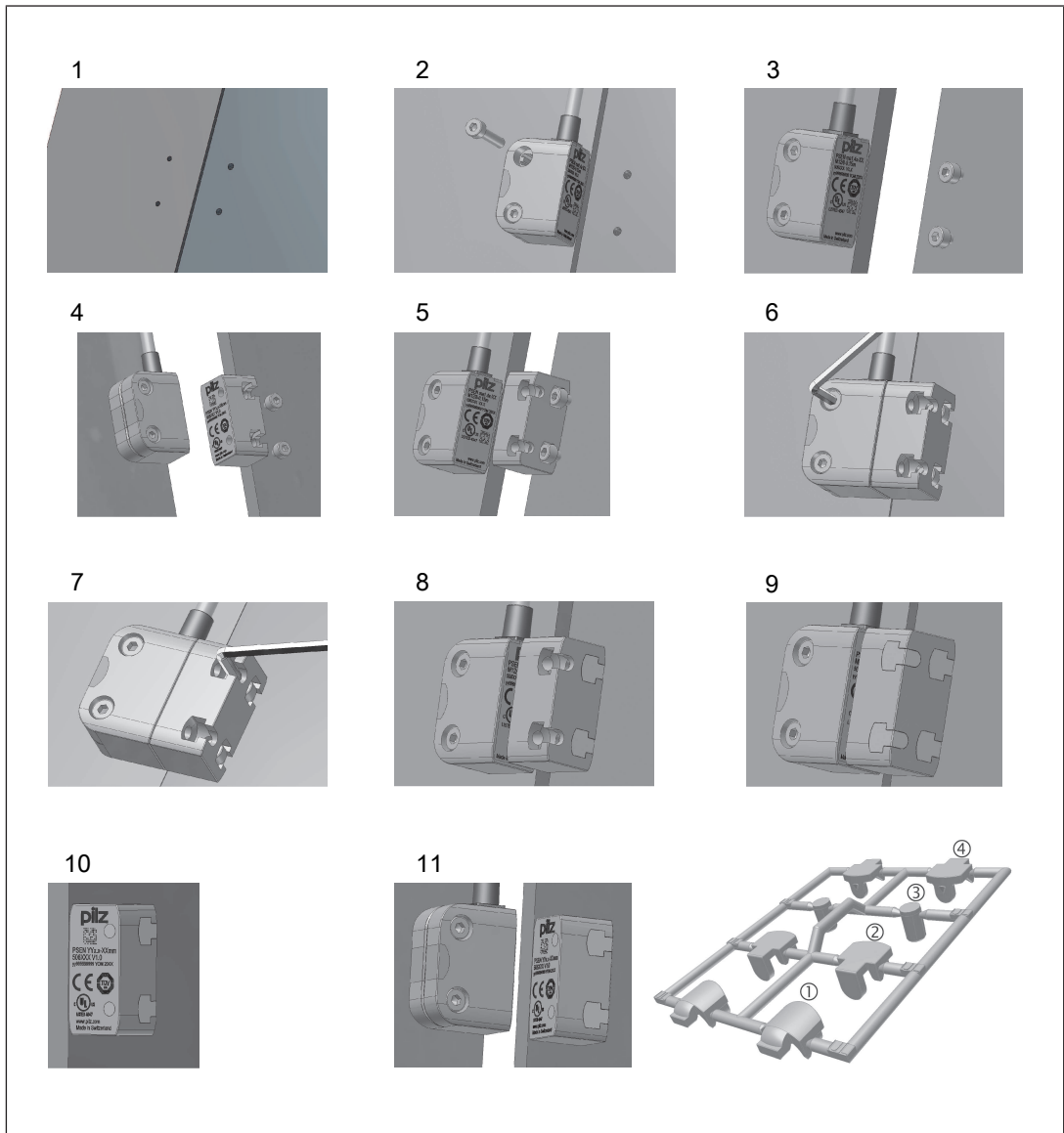

**INFORMATION**

Seals (1), (2), (3) meet the requirements of UL 94 V0, seal (4) does **not** meet UL requirements.

**Installation type 2**

Install the sensor as shown for installation type 1

- ▶ 1. Attach the screws for the actuator, maintaining the distance between the screw head and the plate: ca. 3 ... 6 mm.
- ▶ 2. Close unused mounting holes on the plate using seal (2) (see [Diagram \[15\]](#)).
- ▶ 3. Slide the actuator on to the screws.
- ▶ 4. Align actuator and tighten screws with max. 0,8 Nm.
- ▶ 5. Close used mounting holes using seal (1) or (4) (see [Diagram \[15\]](#)).
- ▶ 6. Close mounting holes on the sensing face using seal (3) (see [Diagram \[15\]](#)).
- ▶ 7. Installation of sensor and actuator is now complete.

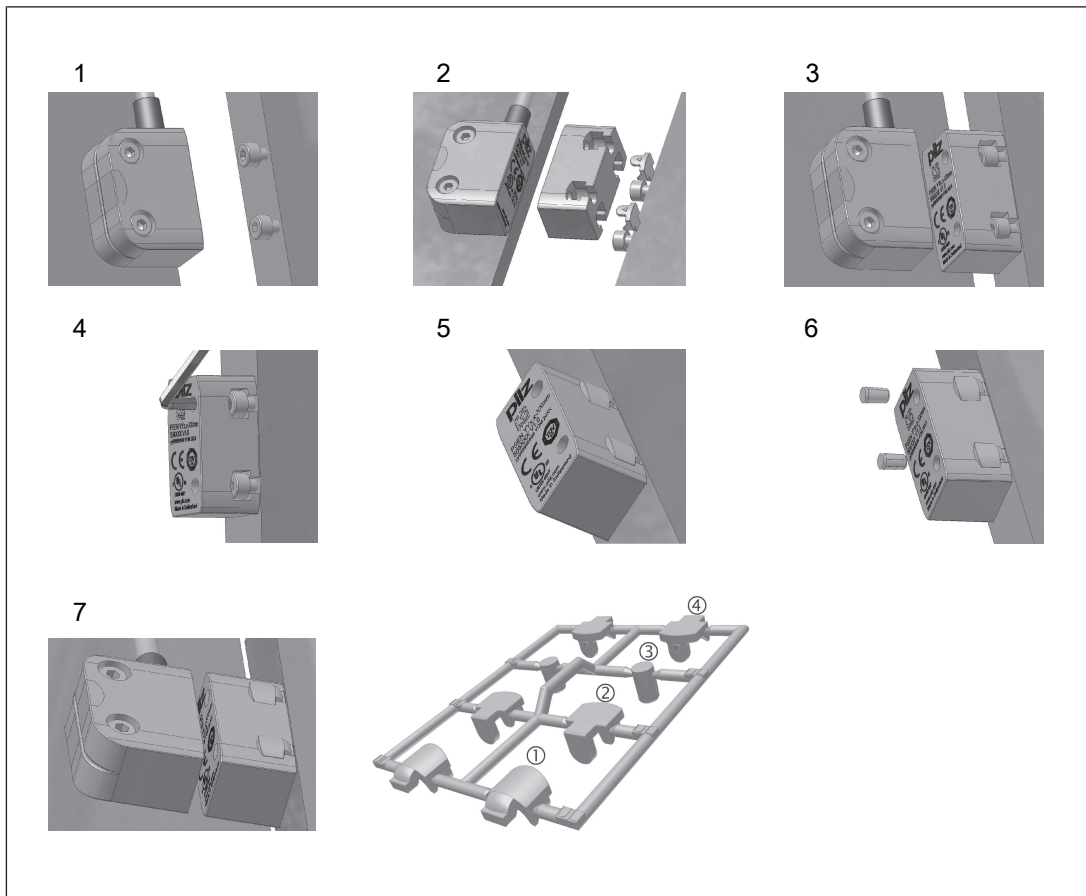

#### INFORMATION

Seals (1), (2), (3) meet the requirements of UL 94 V0, seal (4) does **not** meet UL requirements.

#### Adjustment

- ▶ The safety switch may only be used with the corresponding actuator PSEN ma1.4-03 or PSEN ma1.4-10.
- ▶ Always test the function with a connected evaluation device.

- ▶ The stated operating distances (see [Technical details \[16\]](#)) only apply when the safety switch and actuator are installed according to the specifications [Installation \[12\]](#). Operating distances may deviate if other arrangements are used. Note the maximum permitted lateral and vertical offset (see [Operating distances and Lateral and vertical offset \[8\]](#)).

**Periodic test**

- ▶ Carry out a monthly function test on the safety switch and actuator.
- ▶ Always test the function with a connected evaluation device.
- ▶ The safety function may only be checked by qualified personnel.

**Dimensions in mm**

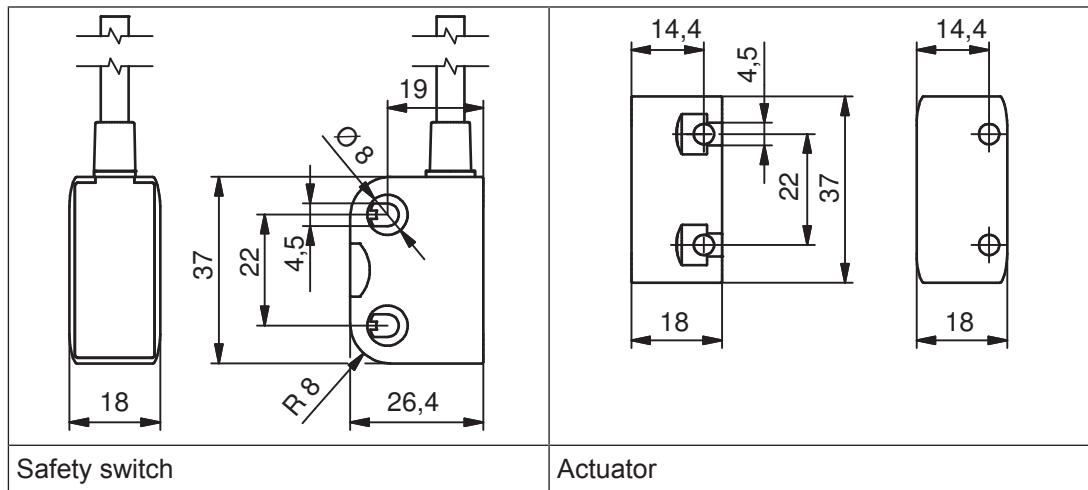

**Technical details**

General	506320	506322
Approvals	CE, EAC (Eurasian), TÜV, cULus Listed	CE, EAC (Eurasian), TÜV, cULus Listed
Sensor's mode of operation	Magnetic	Magnetic
Coding level in accordance with ISO 14119	Low	Low
Design in accordance with EN ISO 14119	4	4
Classification in accordance with EN 60947-5-3	PDDB	PDDB
Electrical data	506320	506322
Supply voltage		
Voltage	24 V	24 V
Kind	DC	DC
Voltage tolerance	-20 %/+20 %	-20 %/+20 %
Supply voltage		
Max. current	200 mA	200 mA



<b>Electrical data</b>	<b>506320</b>	<b>506322</b>
Max. switching frequency	1 Hz	1 Hz
Lowest operating current (I <sub>m</sub> )	1 mA	1 mA
Switching voltage	24 V	24 V
Internal resistance	10 Ohm	10 Ohm
Max. switching current, safety contacts	0,2 A	0,2 A
Max. breaking capacity, safety contacts	5 W	5 W
<b>Times</b>	<b>506320</b>	<b>506322</b>
Reaction time (actuator removed)	2 ms	2 ms
<b>Environmental data</b>	<b>506320</b>	<b>506322</b>
Ambient temperature		
Temperature range	-10 - 55 °C	-10 - 55 °C
Climatic suitability		
In accordance with the standard	IEC 60068-2-30	IEC 60068-2-30
Humidity	93 % r. h. at 40 °C	93 % r. h. at 40 °C
Max. operating height above sea level	2000 m	2000 m
EMC	EN 60947-5-3	EN 60947-5-3
Vibration		
In accordance with the standard	EN 60947-5-2	EN 60947-5-2
Frequency	10 - 55 Hz	10 - 55 Hz
Amplitude	1 mm	1 mm
Shock stress		
Acceleration	30g	30g
Duration	11 ms	11 ms
Airgap creepage		
Pollution degree	3	3
Rated insulation voltage	250 V	250 V
Rated impulse withstand voltage	4 kV	4 kV
Protection type		
Housing	IP6K9K	IP6K9K
<b>Mechanical data</b>	<b>506320</b>	<b>506322</b>
Actuator 1	PSEN ma1.4-03mm	PSEN ma1.4-10mm
Typ. Hysteresis	2,5 mm	3,5 mm
Operating distances		
Assured operating distance S <sub>ao</sub>	3 mm	10 mm
Min. operating distance S <sub>omin</sub>	0,0 mm	0,0 mm
Typical operating distance S <sub>o</sub>	3,5 mm	12,5 mm
Assured release distance S <sub>ar</sub>	12 mm	22 mm
Typical release distance S <sub>r</sub>	6 mm	16 mm
Repetition accuracy switching distances	6 %	6 %
Min. distance between safety switches	50 mm	50 mm

<b>Mechanical data</b>	<b>506320</b>	<b>506322</b>
Sensor flush installation in accordance with EN 60947-5-2	<b>Yes, follow installation guidelines</b>	<b>Yes, follow installation guidelines</b>
Connection type	<b>5 m cable</b>	<b>5 m cable</b>
Cable	<b>LiY11Y 4 x 0,25 mm<sup>2</sup></b>	<b>LiY11Y 4 x 0,25 mm<sup>2</sup></b>
Material		
Top	<b>PBT</b>	<b>PBT</b>
Max. torque setting		
Safety switch	<b>0,8 Nm</b>	<b>0,8 Nm</b>
Actuator 1	<b>0,8 Nm</b>	<b>0,8 Nm</b>
Dimensions		
Height	<b>37 mm</b>	<b>37 mm</b>
Width	<b>26,4 mm</b>	<b>26,4 mm</b>
Depth	<b>18 mm</b>	<b>18 mm</b>
Actuator dimensions		
Height	<b>37 mm</b>	<b>37 mm</b>
Width	<b>18 mm</b>	<b>18 mm</b>
Depth	<b>18 mm</b>	<b>18 mm</b>
Weight of safety switch	<b>180 g</b>	<b>180 g</b>
Weight of actuator	<b>16 g</b>	<b>18 g</b>
Weight	<b>196 g</b>	<b>198 g</b>

Where standards are undated, the 2015-09 latest editions shall apply.

#### Safety characteristic data



#### NOTICE

You must comply with the safety-related characteristic data in order to achieve the required safety level for your plant/machine.

<b>B10d in accordance with EN ISO 13849-1: 2015 and EN 62061</b>	<b>TM [year] in accordance with EN ISO 13849-1:2015</b>
<b>7.300.000</b>	<b>20</b>

## Order reference

### System

Product type	Features	Connection type	Order no.
PSEN ma1.4a-50/ PSEN ma1.4-03mm/ 1unit	Magnetic safety switch, actuator with assured operating distance 3 mm	5 m cable	506 320
PSEN ma1.4a-50/ PSEN ma1.4-10mm/ 1unit	Magnetic safety switch, actuator with assured operating distance 10 mm	5 m cable	506 322
PSEN ma1.4a-50/ 1switch	Magnetic safety switch	5 m cable	506 302
PSEN ma1.4-03mm 1actuator	Actuator with assured operating distance 3 mm		506 300
PSEN ma1.4-10mm 1actuator	Actuator with assured operating distance 10 mm		506 301

### Accessories

#### Connector

Product type	Features	Order no.
PSS67 M12 connector	Connector, M12, straight, 5-pin, A-coded	380 308
PSS67 M12 connector	Connector, M12, angled, 5-pin, A-coded	380 310

### EC declaration of conformity

This product/these products meet the requirements of the directive 2006/42/EC for machinery of the European Parliament and of the Council. The complete EC Declaration of Conformity is available on the Internet at [www.pilz.com/downloads](http://www.pilz.com/downloads).

Representative: Norbert Fröhlich, Pilz GmbH & Co. KG, Felix-Wankel-Str. 2, 73760 Ostfildern, Germany